



# OPERATION AND MAINTENANCE MANUAL

SKD-BE830L

SKD-BE850L

SKD-BE830LF

SKD-BE830P

SKD-BE830PF

SKD-BE850P

Ver. 3.0

**DC-TYPE Non-Carbon-Brush Electric Screwdrivers**

**KILEWS INDUSTRIAL CO., LTD.**

[www.kilewest.com](http://www.kilewest.com)

KILEWS WEST USA INC. - 6945 LTC PKWY - PORT ST LUCIE, FL 34986  
PHONE (772) 293-0071 FAX (772) 465-4368 EMAIL SALES@KILEWSWEST.COM

Y2F055A-E-004

## NOTICE

Metal Assembly Screwdrivers are designed for installing threaded fasteners in light industrial and appliance manufacturing applications.

KILEWS is not responsible for customer modification of tools for applications on which KILEWS was not consulted.

## WARNING

### **Important safety information enclosed.**

Read all these instructions before placing tool in service or operation this tool and save these instructions. It is the responsibility of the employer to place the information in this manual into the hands of the operator. Failure to observe the following warnings could result in injury. When using electric tools, Basic safety precautions should always be followed to reduce the risk of fire, electric shock and personal injury, including the following:

## Important Safety Rules

**WARNING!** Read all instructions. Failure to follow all instructions listed below may result in electric shock, fire and/or serious injury. The term “power tool” in all of the warning listed below refer to your mains operated (corded) power tool or battery operated (cordless) power tool.

SAVE THESE INSTRUCTIONS

### 1) Electrical Safety

- a) **Keep work area clean and well lit.** Cluttered and dark areas invite accidents.
- b) **Do not operate power tools in explosive atmosphere, such as in the presence of flammable liquids, gases or dust.** Power tools create sparks which may ignite the dust or fumes.
- c) **Keep children, and bystanders away while operating a power tool.** Distractions can cause you to lose control.

### 2) Electrical Safety

- a) **Power tool plugs must match the outlet. Never modify the plug in any way. Do not use any adapter plugs with earthed (grounded) power tools.** Unmodified plugs and matching outlets will reduce risk of electric shock.
- b) **Avoid body contact with earthed or grounded surfaces such as pipes, radiators, ranges and refrigerators.** There is an increased risk of electric shock if your body is earthed or grounded.
- c) **Don't expose power tools to rain or wet conditions.** Water entering a power tool will increase the risk of electric shock.
- d) **Do not abuse the cord. Never use the cord for carrying, pulling or unplugging the power tool. Keep cord away from heat, oil, sharp edges or moving parts.** Damaged or entangled cords increase the risk of electric shock.
- e) **When operating a power tool outdoors, use an extension cord suitable for outdoor use.** Use of cord suitable for outdoor use reduces the risk of electric shock.

### 3) Personal Safety

- a) **Stay alert, watch what you are doing and use common sense when operating a power tool. Do not use power tool while you are tired or under the influence of drugs, alcohol, or medication.** A moment of inattention while operating power tools may result in serious personal injury.
- b) **Use safety equipment. Always wear eye protection.** Safety equipment such as dust mask, non-skid safety shoes, hard hat, or hearing protection used for appropriate conditions will reduce personal injuries. Rubber gloves and non-skid footwear are recommended when working outdoors.
- c) **Avoid accidental starting. Ensure the switch is in the off position before plugging in.** Carrying power tools with your finger on the switch or plugging in power tools that have the switch on invites accidents.
- d) **Remove any adjusting keys or wrench before turning the power tool on.** A wrench or a key that is left attached to a rotating part of the power tool may result in personal injury.
- e) **Do not overreach. Keep proper footing and balance at all times.** This enables better control of the power tool in unexpected situations.
- f) **Dress properly. Do not wear loose clothing or jewellery. Keep your hair, clothing, and gloves away from moving parts.** Loose clothes, jewellery, or long hair can be caught in moving parts.
- g) **Secure work.** Use clamps or a vice to hold the work. It is safer than using your hand and frees both hands to operate the tool.
- h) **If devices are provided for the connection of dust extraction and collection facilities, ensure these are connected and properly used.** Use of these devices can reduce dust related hazards.

#### 4) Power tool Use and Care

- a) **Do not force the power tool. Use the correct power tool for your application.** The correct power tool will do the job better and safer at the rate for which it was designed.
- b) **Do not use power tool if switch does not turn it on or off.** Any power tool that cannot be controlled with the switch is dangerous and must be repaired.
- c) **Disconnect the plug from the power source before making any adjustments, changing accessories, or storing the power tools.** Such preventive safety measures reduce the risk of starting the power tool accidentally.
- d) **Store idle power tools out of reach of children and do not allow persons unfamiliar with the power tool or these instructions to operate the power tool.** Power tools are dangerous in the hands of untrained users.  
Do not let visitors touch the tool or extension cord. All visitors should be kept away from work area.
- e) **Maintain power tools. Check for misalignment or binding of moving parts, breakage of parts and any other condition that may affect the power tools operation. If damaged, have the power tool repaired before use.** Many accidents are caused by poorly maintained power tools.  
Inspect extension cords periodically and replace, if damaged.
- f) **Keep cutting tools sharp and clean,** Properly maintained cutting tools with sharp cutting edges are less likely to bind and are easier to control.
- g) **Use the power tools, accessories and tool bits ect., in accordance with these instructions and in the manner intended for the particular type of power tool, taking into account the working conditions and the work to be performed.** Use of the power tool for operations different from intended could result in a hazardous situation.

#### 5) SERVICE

- a) Have your power tool serviced by qualified repair person using only identical replacement parts, This will ensure that the safety of the power tool is maintained.

#### **Additional information shall be provide**

- a) Instruction for putting into use
  1. Setting-up or fixing power tool in a stable position as appropriate for power tools which can be mounted on a support.
  2. Assembly
  3. Connection to power supply, cabling, fusing, socket type and earthing requirements.
  4. Illustrated description of functions.
  5. Limitations on ambient conditions.
  6. List of contents.
- b) Operating Instructions.
  1. Setting and testing.
  2. Tool changing.
  3. Clamping of work.
  4. Limits on size of work piece.
  5. General instructions for use.
- c) Maintenance and servicing.
  1. Regular cleaning, maintenance, and lubrication.
  2. Servicing by manufacture or agent, list of addresses.
  3. List of user-replaceable parts.
  4. Special tools which may be required.

**WARNING !**   
**DO NOT OPERATE THIS TOOL WITHOUT  
PROTECTIVE EARTH CONNECTED**

**Grounding Instructions**

- 1、 This tool should be grounded while in use to protect the operator from electric shock. NOTICE ! To ensure the grounding result, the grounding conductor of the power cord must be well connected with the grounding terminal of power facility. This tool is equipped with grounding conductors. The Green(or Green and Yellow)conductor in the Power Cord is the grounding wire. Never connect Green (or Green and Yellow) to a live terminal. The grounding wires in this tool can not only earth the electric leakage safely, but also can eliminate ESD-the electrostatic that tool occurred while in use.
- 2、 The grounding is the most important task a user. Periodically, depends on the working condition and circumstance, for maintaining a good function the user has to check the grounding condition every 3~6 months by an electric meter and following simple steps; Set the Ohm meter to level R\*100(Ohm). Touching 2 test rods (“+” & “-”) together and reset the meter to “0”. Using the Red(“+”) rod to touch the Grounding wire on the Plug of controller’s cord, and the Black(“-”) rod to the end of Bit Head. It stands for the grounding is normal if the meter is read as close as to “0”. For getting a normal indication on the meter while in testing, need to press the test rods firmly to the testing objects.
- 3、 The instrument QC of the tool is performed before the tool ex-factory. The grounding continuity test is conducted by input 26A voltage to the end of earth terminal, and subject to the resistance value lower than 0.30hm.

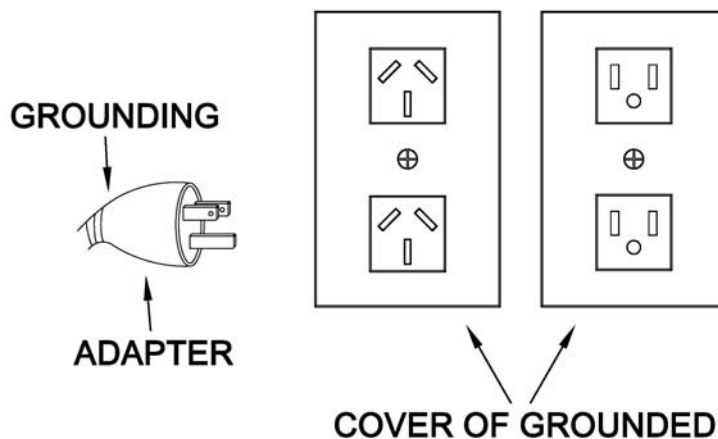

## Operations Cautions

- 1) Whenever changing a bit, make certain the Forward / Reverse Switch is in the “ OFF “ position and tool is unplugged.
- 2) Do not allow chemicals such as acetone, benzene, thinner, trichloroethylene ketone, or other similar chemicals to come in contact with the screwdriver housing as damage will result.
- 3) Do not drop or abuse the screwdriver.
- 4) Do not adjust the torque setting higher than 8 on the torque scale.
- 5) There should be a tool rest interval when cycles three seconds or longer. This tool is intended for a duty cycle of 1.0 sec on, 3.0 sec off.
- 6) Do not use this screwdriver for tightening wood screws. This is “ Metal Assembly Screw Driver ”
- 7) Do not operate the Forward / Reverse Switch the motor is running.
- 8) Whenever a tool is not being used, move the Forward / Reverse Switch to the “OFF” position and unplug the screwdriver.
- 9) Don't touch For&Rew Switch during operating for keeping system from wrong judgement.

### CAUTION

- Do not drop or abuse the tool.
- Whenever a tool is not being used, position the Power Switch to the “OFF” position and unplug the power cord.

## Description of Operation

Attaching / detaching bit and bit type

Push up the holder clamp by finger tip, and it will be unlocked. Thus, the bit can be freely attached and detached (single finger notion type) select such a bit whose shank is equal to the size shown below.

- Insert the power plug into a receptacle and set the changeover switch to “F” position.
- Apply the bit to the screw head and press the lever or push main body to, then the switch will be turned ON to start the motor running.
- When the screw is tighten and reach the torque that you had set, The tool will stopped automatically.
- To reset the tool by releasing the lever to the original position or releasing the bit From the screw head.
- To return the screw, set the changeover switch to “R” position.

## Servicing

### Maintenance and Inspection:

1. The screw driver must be operated in top condition, one day working hour must be not more than eight hours.
2. Please note don't let the motor get over heated, every minute use 10~15 screws to operate.
3. The frequency use of this electric screw driver is over than eight hours a day, still it needs periodically testing and treatment. Every 5-6 months.
4. Inspect tool cords periodically and if damaged, have them repaired by an authorized service facility. Inspect extension cords periodically and replace if damaged.
5. Do not remove any labels. Replace any damaged label.

**CAUTION**

1. The use of other than genuine KILEWS replacement parts may Result in decreased tool performance and increased maintenance, and may invalidate all warranties.
2. All repairs and maintenance of this tool and its word must be performed by an authorized service center.
3. KILEWS is not responsible for customer modification of tools for applications on which KILEWS was not consulted.
4. Repairs should by made only by authorized, trained personnel. Consult your nearest KILEWS authorized service center.
5. It is the responsibility of the employer to place the information in this manual into the hands of the operator.

**DO NOT ATTEMPT TO REPAIR THIS  
ELECTRIC SCREW DRIVER**

**CAUTION**

**SAVE THESE INSTRUCTIONS  
DO NOT DESTROY**

---

## Specifications

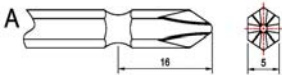
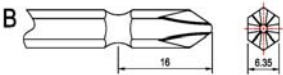
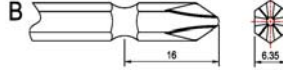
MODEL		SKD-BE830L	SKD-BE830P	SKD-BE830LF	SKD-BE830PF	SKD-BE850L	SKD-BE850P
Input voltage(DC)		DC 40V					
Power Consumption		90W	90W	90W	90W	120W	120W
Torque	(kgf.cm)	10-30	10-30	10-30	10-30	20-50	20-50
	(Lbf.in)	8.67-26.02	8.67-26.02	8.67-26.02	8.67-26.02	17.35-43.37	17.35-43.37
	(N.m)	0.98-2.94	0.98-2.94	0.98-2.94	0.98-2.94	1.96-4.90	1.96-4.90
Repeatable Torque Accuracy (%)		±3%					
Torque Adjustment		Step less					
Unloaded Rotation Speed (R.p.m) ±10%	HI	1000	1000	2000	2000	1000	1000
Screw Size Dia(mm)	Machine screw	2.6~4.0	2.6~4.0	2.6~4.0	2.6~4.0	4.0~5.0	4.0~5.0
	Tapping screw	2.6~3.5	2.6~3.5	2.6~3.5	2.6~3.5	≤4	≤4
Weight (g)		820					
Length (mm)		294					
Model of Torque Fixing Ring		KC-7					
Power controller		SKP-40B					
Model of Suspension Rack		KH-2					
Bit Type		 HEX 5mm		 HEX 6.35mm		 HEX 6.35mm	

\* 1N.m=10.2Kgf.cm    1N.m=8.85Lbf.in

## Accessories

1. BIT Type :
- No. 00 . . . . Bit use in dia 1.3~1.8mm screw
  - No. 0 . . . . . Bit use in dia 1.8~2.0mm screw
  - No. 1 . . . . . Bit use in dia 2.0~2.6mm screw
  - No. 2 . . . . . Bit use in dia 3.0~4.0mm screw
- |            |          |         |             |
|------------|----------|---------|-------------|
| SKD-BE830  | with BIT | 1# & 2# | 1 Pce. Each |
| SKD-BE850  | with BIT | 2#      | 2 Pcs.      |
| SKD-BE830F | with BIT | 1# & 2# | 1 Pce. Each |

- 2.Suspension rack and Torque fixing ring acceptable for use with the tool are available from KILEWS catalogue.
- 3.Torque Fixing Ring KC-7C    1 Pce.

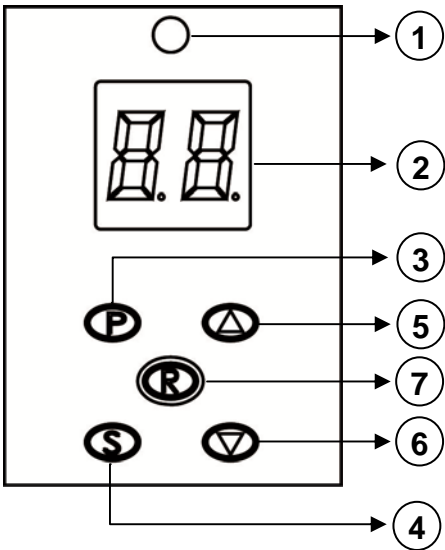

## Panel Specifications

	NO	Name	Function
	1	Three-Color Light	To Show operating is OK, N.G or in the mode condition.
	2	Panel	To show set value, set screws number and other value
	3	Power Switch	Push five seconds: to delete COUNT CLEAR Push three seconds: CLEAR
	4	SELECT Key	Push three seconds: Enter the system
	5	Up Key	When entering the system , this key increases value
	6	Down Key	When entering the system , this key decreases value
	7	Reset	Reset the value of manufacturer
	※	S+P	Automatic learning.
	※	UP+P	Waiting time mode
	※	UP+DOWN	Buzzer mode
	※	S+UP	If press together to enable P/R/S, and then press again to disable P/R/S.

## Counting Set-Up instruction

※Push three seconds to enter the selection ) SL====SC====At====Ht====Lt====LL====Ns====Rn====Rt<Confirm>

Function Name	Set up Time and Value	Description	Buzz Time/ Light	Manufacturer Set-Up Value
SL	01-05/UJ	Screw List	---	---
SC	1-99	Counting number / count-down only	---	05
At	0.1-9.9	Automatic zero time / Signal output time	---	1.0
Ht	0.1-9.9	Ht time Stop time ( Show wrong as screwdriver can't sop at set time after starting, can be used to test stripped screws	Five buzz and LED red flash	2.0
Lt	0.01-9.9	Lt time will show wrong as screwdriver stops before Lt after starting, can test screw is not properly fastened at its position. .	Two buzz and LED red flash	0.02
LL	0.01-9.9	Reconfirm time after fastening.	---	0.02
Ns	Y or N	The processing method when error occurs. Y: When the error signal comes out, the screwdriver stops immediately. User should press "S" button to confirm and release the forward, but reverse is still available. N: When the error signal comes out, the screwdriver will not stop, nor effect the next starting, only shows a warning.		N
Rn	Y or N	Counting for reverse setting. Y: Countdown once per starting of the screwdriver. N: Countdown once only when change to reverse setting.		N
Rt	0.01~9.99	Automatic reverse, set up the working second.		0.00
Backward to Count-Up )	1 COUNT	When screwdriver is backward, the number will be back one	---	---
LC	---	Keypad LOCK P/S/R		
UN	---	UNLOCK		
Ln	---	Automatic learning.	LED keeps flash of light	---
Buzzer	En Wrong Set-Up	Wrong Set-Up, such as Lt > Ht	Three buzz and LED red flash. Automatically show En	Buzzer
	dt Standby Tme	To stop fastening as set-number screws are not completed)	Lasting buzz s and LED red flash	
	tt Working time	The setting number of screws which are not finished fastening within the setting time.	Continual buzzer sound and red LED flash.	

※In the set-up , if Lt and LL show "02"means 0.02, push P to adjust decimal to become 0.2.

※During operation, LED will show three kinds of colors: OK is green light; NG is red light; standby learning is orange light.

※SKD-BE PCB has two kinds of signal, OUTPUT OKALL and N.G and is open collector.

※Output users need input voltage to drive the buzzer, the input voltage can' be over DC24V 10mA.

※New function: When there's a starting signal interrupted before Lt, it will determine N.G

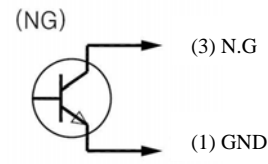
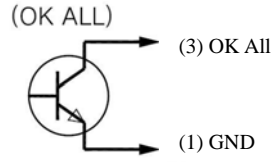
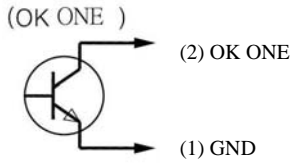
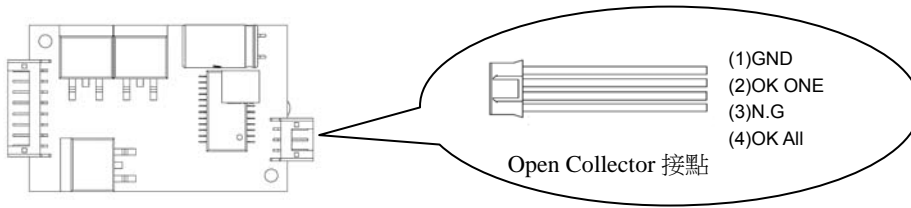

Push both UP + DOWN set up the buzzer :

ON	Fasting a screw, completing work and mistaken operation, buzzer will be on.
OFF	Wrong operation will be buzzed.
FF	Work completed and wrong operation will cause buzz.
EF	As one screw is fastened and work is completed, buzzer will be on; as mistake made has buzz.

Ht/Lt mainly set up the period of time. If stop is within the set period, it means OK. In contras, it will be (NG), as stop before Lt or after Ht. and should reconfirm whether wrong screws is taken. More precise requested means more correct Ht/Lt set-up should be. The Lt accepts 0.00, but it can be increased or decreased in SELECT.

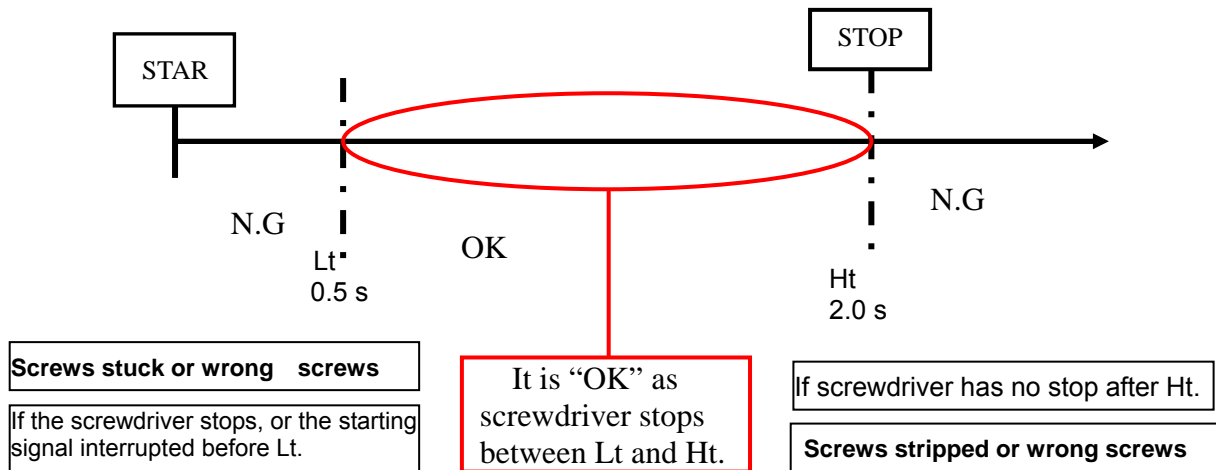

※To shut down the count: If count needs be shut down, push P key for five seconds until no figures on the panel , meanwhile LED 1 will show green light.

※If set value need be reset during counting, just push three seconds.

※Simulate-learning: as electric screwdriver is not used, push S key, then push P key to enter simulate-learning procedure;

SL(S)===SC(S)===At(S)=== Test Data===(P)

- 1) Show SL (Screw List), select UP/DOWN to change number and then push S(confirm)
- 2) Show SC (counting number), select UP/DOWN to change number and then push S(confirm)
- 3) Show At (automatic zero), UP/DOWN to change value; then push P (confirm)
- 4) Enter simulate-learning (LED 1 will keep flash)
- 5) When recording value, push P key and back working condition.

- ※LED light flash in simulate-learning.( means under simulate- learning condition), push P key to record value after simulate -learning. )
- ※When the screwdriver is left unused: Press “Up” then press “P”, set up the waiting time. Press again “P” to set up the total finishing time 00~99. If set 1 minute, it will count the time after starting the screwdriver. If the setting screw number are not finished within 1 minute, the buzzer sound will come out.
- ※Press “P” to reset the system back to the default setting when the user needs it.

### Work under default setting:

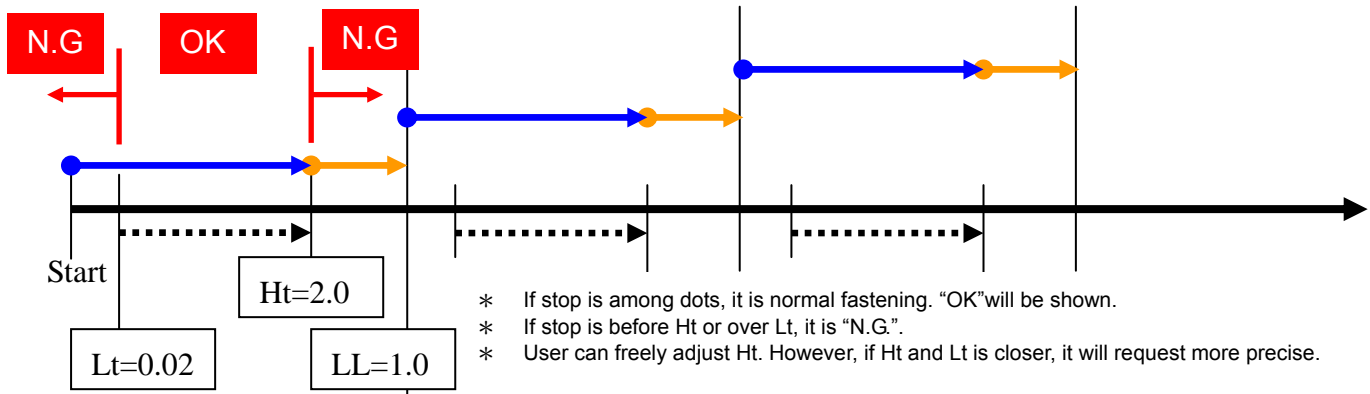

## Torque Adjustment Operation

To adjust the torque on these screwdrivers. Proceed as follows :

1. Determine the torque output of the tool by checking a tightened Fastener with a torque wrench.
2. Increase or decrease the torque by rotating the Spring Adjusting Ring. Rotating the Ring clockwise to a higher number on the torque Scale increase torque output while rotating the Ring counterclockwise to a lower number decreases the torque output.
3. Check the adjustment with a torque wrench. A number of factors will affect torque output from one job to another. Final torque adjustment should be made at the job through a of series of gradual increase. Always start below the desired torque and work upward.
4. Adjust the bit torque by changing the driving in length of the adjust ring at the end.
5. The relationship between torque scale and bit torque is as shown Ring, in the torque diagram. The figures of torque scale do not indicate bit torque values. However, the clamping torque of screw itself is different form type, size, material of the screw and the material of its mating part. Use it as standard to obtain an appropriate clamping torque.
6. The (Return torque method) in which once-clamped screw is returned with torque wrench or the like is available as one of torque control methods however, note that the measured values by the return torque method generally appear in 10%~30% lower than the actually clamping torque.
7. The torque checker measures the torque of screwdriver. The clamping torque of screw itself is different from the clamped conditions. Understand the correlation between clamping torque values and the torque checker values perform the torque control properly.

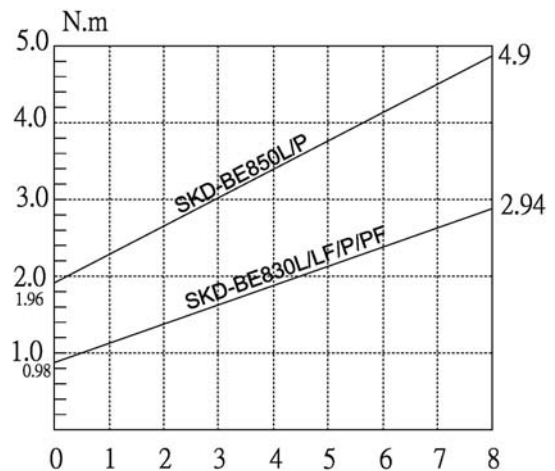

**CAUTION**

1. Also in reverse rotation, the clutch is turned off in such manner as in normal rotation, stopping the motor running. Accordingly, when the screw tightened at a large torque, set it to a higher torque scale.
2. The number from zero to eight on the Torque Scale is reference number only and not an indication of actual torque output.
3. The mechanical wear condition of the electric screwdriver depends on the torque, duration, and the frequency that user used. In the case of using greater torque, the higher frequency and the longer operation, the screwdriver will get worn faster. The new screwdriver uses in the scale of 4 for one month (frequency: 12 pcs/ min; 8 hours / per day) will result in 3% ~ 5% torque decay. (Scale of 8 will result in 5% ~ 7% torque decay). By the growth in use of time, the torque decay level will gradually reduce and stabilize. User could test the torque output of the screwdriver by torque meter periodically and then adjust it to meet user's requirement for the compensation of the torque decay.
4. The power supplier will generate low power when the button of the power controller is switched to "LO." Also, the electric screwdriver's torque output setting value should be adjusted to middle torsion value accordingly.
5. Please refer to Kilews website <http://www.kilews.com> for the detail component list.

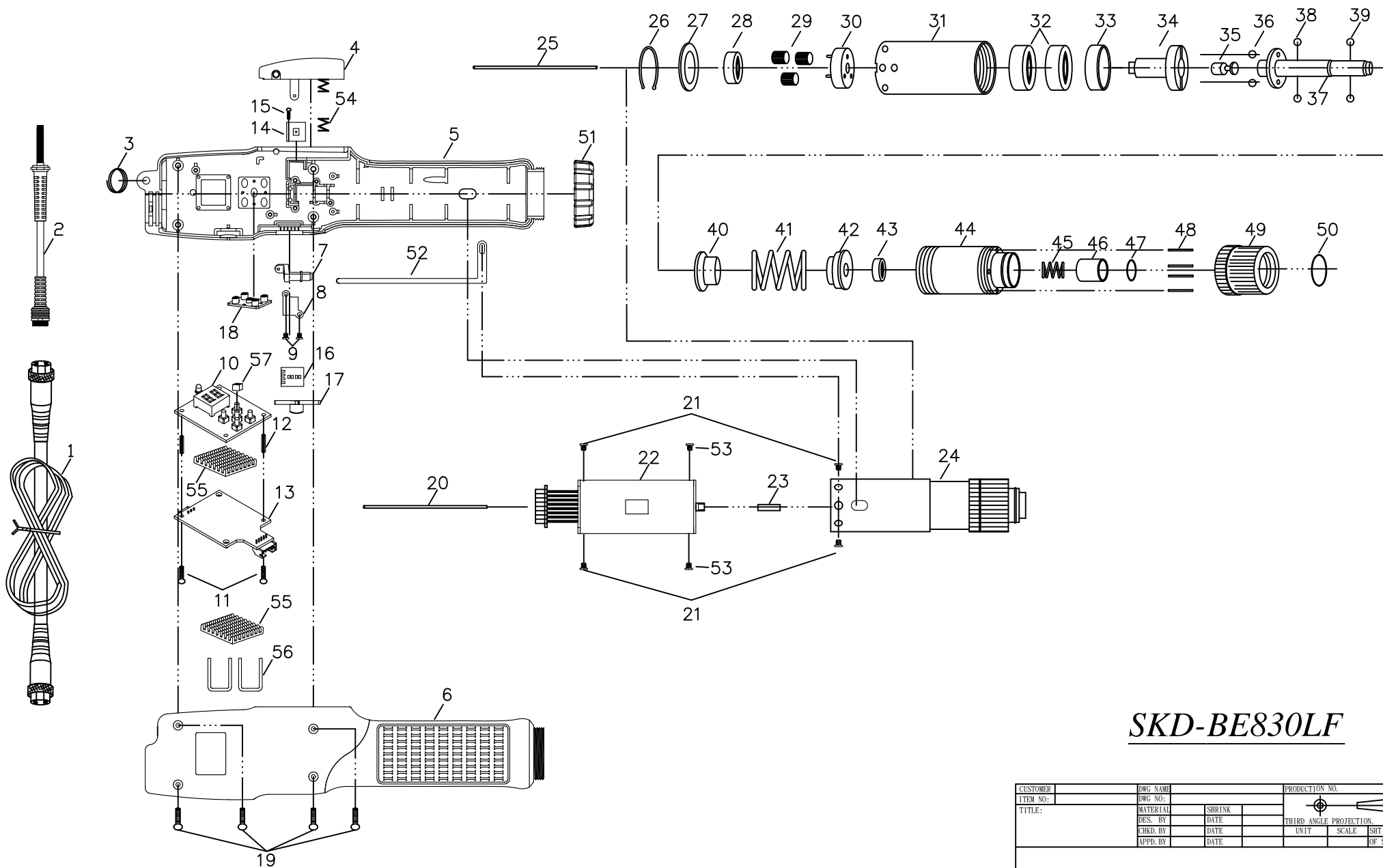

# SKD-BE830LF

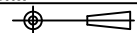
CUSTOMER	DWG NAME	PRODUCTION NO.	
ITEM NO:	DWG NO:	 THIRD ANGLE PROJECTION	
MATERIAL	SIRINK		
DES. BY	DATE		
CHKD. BY	DATE		
APPD. BY	DATE		
	UNIT	SCALE	SHT NO. OF SHTS.

NO	PARTS NO	PARTS NAME-E	PARTS NAME-C	Q'ty	NO	PARTS NO	PARTS NAME-E	PARTS NAME-C	Q'ty
1	AA50001-21	CORD ASSEMBLY 2M	電源線 2M	1	30	GG21515	GEAR SEAT	三點齒盤	1
2	AA50001-58N	CORD ASSEMBLY	電源線	1	31	GA81101	GEAR CASE	上離合器筒	1
3	CJ20011	SUSPENSION RING	起子吊環	1	32	GN21251	MAIN BEARING	離合器主軸承	2
4	CC50017	TRIGGER ASSEMBLY	手按開關半成品	1	33	GW21532	IRON RING	鐵墊圈	1
	CC50017-1	TRIGGER ASSEMBLY FOR ESD	手按開關半成品(防靜電)	1	34	GC90305	CAM	上離合器頭	1
5	C40751F	HOUSING-UNDERSIDE (A'ssy)	下蓋半成品	1	35	GU30370	STOP PILOT FOR "A"	停止用酒杯(A)	1
	C40751-1F	HOUSING-UNDERSIDE-ESD (A'ssy)	下蓋半成品-防靜電	1		GU30371	STOP PILOT FOR "B"	停止用酒杯(B)	1
6	CA80101-4	HOUSING-UPSIDE	上蓋	1	36	GP30361	STELL BALLS 5φ	跳脫鋼珠 5φ	2
	CA80101-5	HOUSING-UPSIDE (ESD)	上蓋-防靜電	1	37	GD91404-3	SHAFT FOR "LB" TYPE	傳動軸 BE800LB	1
7	CE50152-3	PUSH ROD	開關推桿半成品	1		GD91408-1	SHAFT FOR "LA" TYPE	傳動軸 BE800LA	1
8	CE80001	FIXTURE	三合一固定片	1	38	GP30351	STELL BALLS 4φ	酒杯鋼珠 4φ	2
9	CH30200	SCREW FOR FIXTURE	三合一固定片螺絲	2	39	GP21291A	STEEL BALLS FOR "LA" TYPE(3φ)	起子頭帽鋼珠 3φ	2
10	EG31419-4F	PCB	計數機板成品	1		GP21291B	STEEL BALLS FOR "LB" TYPE(2.5φ)	起子頭帽鋼珠 2.5φ	2
11	CH90156	SCREW	螺絲	2	40	GF90324	WARING PLATE	扭力推盤	1
12	W50114	PC BOARD GAP COLUMN	PC板間隔柱	2	41	GE92389	WARING SPRING FOR "B830L"	扭力彈簧	1
13	EG31419-5	PCB	驅動機板成品	2	42	GY21321	WARING SPRING BASE	止推盤	1
14	EG31420-1	START SWITCH	啟動開關半成品	1	43	GN30434	BEARING	軸承	1
15	CH30201	SCREW TP2*4mm FOR START SWITCH	螺絲	1	44	G20206-1	CLUTCH CASE	下離合器筒	1
16	EG31421-1	PCB-CHANGEOVER	正反開關半成品	1	45	GO21341-2	BIT SPRING	起子頭彈簧	1
17	CI50212-1	F/R SWITCHING ELEMENT	正反轉推板半成品	1	46	GJ21351	BIT SLEEVE	起子頭帽	1
18	C50213	BOTTOM	矽膠按鍵	1	47	GQ21361	"C" RING	起子頭帽C環	1
19	CH20102	SCREW FOR HOUSING	螺絲	4	48	GL21371	TORQUE ADJUST PIN	扭力調整棒	4
20	MI90584	PILOT ROD	開關引導棒	1	49	GM21381	TORQUE ADJUST RING	扭力調整環	1
21	CH20102-24	SCREW FOR MOTOR	馬達螺絲	4	50	GS21391	"C" RING	調整環C環	1
22	MO80030CE	MOTOR ASSEMBLY	馬達整組	1	51	CD91033	COUPLER	前鎖環	1
23	MG30081-2	PILOT ROD	陶瓷棒	1		CD91033-1	COUPLER FOR ESD	前鎖環(防靜電)	1
24	GZ83001-3A	CLUTCH ASSEMBLY FOR "BE830LFA"	離合器成品, BE830LFA	1	52	CH30674C	GROUNDING MEANS	接地線	1
	GZ83001-6B	CLUTCH ASSEMBLY FOR "BE830LFB"	離合器成品, BE830LFB	1	53	CH20504-12	SCREW	螺絲	2
25	MI30511-4	PILOT ROD	引導棒無導磁	1	54	CK28031-1	TRIGGER SPRING	壓板彈簧	1
26	GK21181	"C" RING	齒輪固定C環	1	55	E32202	HEAT SINK	散熱片	2
27	GI21191	IRON WASHER	齒輪固定片	1	56	W50109-1	CLAMP	散熱片夾簧	2
28	G21304	WASHER (HIGH SPEED)	快速墊圈	1	57	C50226	Fixture	開關保護蓋	1
29	GH92239	IDLE GEAR	游星齒輪	3					