



# OPERATION AND MAINTENANCE MANUAL

SKD-BE512L

SKD-BE519L

SKD-BE512LF

SKD-BE517LF

SKD-BE512P

SKD-BE519P

SKD-BE512PF

SKD-BE517PF

Ver. 3.0

**DC-TYPE Automatic Non-Carbon-Brush with Counter Series**  
**KILEWS INDUSTRIAL CO., LTD.**

[www.kilewest.com](http://www.kilewest.com)

KILEWS WEST USA INC. - 6945 LTC PKWY - PORT ST LUCIE, FL 34986  
PHONE (772) 293-0071 FAX (772) 465-4368 EMAIL SALES@KILEWSWEST.COM

Y2F032A-E-003

**NOTICE**

Metal Assembly Screwdrivers are designed for installing threaded fasteners in light industrial and appliance manufacturing applications.

KILEWS is not responsible for customer modification of tools for applications on which KILEWS was not consulted.

**WARNING****Important safety information enclosed.**

Read all these instructions before placing tool in service or operation this tool and save these instructions. It is the responsibility of the employer to place the information in this manual into the hands of the operator. Failure to observe the following warnings could result in injury. When using electric tools, Basic safety precautions should always be followed to reduce the risk of fire, electric shock and personal injury, including the following:

## Important Safety Rules

**WARNING!** Read all instructions Failure to follow all instructions listed below may result in electric shock fire and/or serious injury. The term “power tool” in all of the warning listed below refers to your mains operated (corded) power tool or battery operated (cordless) power tool.

### SAVE THESE INSTRUCTIONS

#### 1) Electrical Safety

- a) **Keep work area clean and well lit.** Cluttered and dark areas invite accidents.
- b) **Do not operate power tools in explosive atmosphere, such as in the presence of flammable liquids, gases or dust.** Power tools create sparks which may ignite the dust or fumes.
- c) **Keep children and bystanders away while operating a power tool.** Distractions can cause you to lose control.

#### 2) Electrical Safety

- a) **Power tool plugs must match the outlet. Never modify the plug in any way. Do not use any adapter plugs with earthed (grounded) power tools.** Unmodified plugs and matching outlets will reduce risk of electric shock.
- b) **Avoid body contact with earthed or grounded surfaces such as pipes, radiators, ranges and refrigerators.** There is an increased risk of electric shock if your body is earthed or grounded.
- c) **Don't expose power tools to rain or wet conditions.** Water entering a power tool will increase the risk of electric shock.
- d) **Do not abuse the cord. Never use the cord to carrying, pulling or unplugging the power tool. Keep cord away from heat, oil, sharp edges or moving parts.** Damaged or entangled cords increase the risk of electric shock.
- e) **When operating a power tool outdoors, use an extension cord suitable for outdoor use.** Use of cord suitable for outdoor use reduces the risk of electric shock.

#### 3) Personal Safety

- a) **Stay alert, watch what you are doing and use common sense when operating a power tool. Do not use power tool while you are tired or under the influence of drugs, alcohol, or medication.** A moment of inattention while operating power tools may result in serious personal injury.
- b) **Use safety equipment. Always wear eye protection.** Safety equipment such as dust mask, non-skid safety shoes, hard hat, or hearing protection used for appropriate conditions will reduce personal injuries. Rubber gloves and non-skid footwear are recommended when working outdoors.
- c) **Avoid accidental starting. Ensure the switch is in the off position before plugging in.** Carrying power tools with your finger on the switch or plugging in power tools that have the switch on invites accidents.
- d) **Remove any adjusting keys or wrench before turning the power tool on.** A wrench or a key that is left attached to a rotating part of the power tool may result in personal injury.
- e) **Do not overreach. Keep proper footing and balance at all times.** This enables better control of the power tool in unexpected situations.
- f) **Dress properly. Do not wear loose clothing or jewellery. Keep your hair, clothing, and gloves away from moving parts.** Loose clothes, jewellery, or long hair can be caught in moving parts
- g) **Secure work.** Use clamps or a vice to hold the work. It is safer than using your hand and frees both hands to operate the tool.
- h) **If devices are provided for the connection of dust extraction and collection facilities, ensure these are connected and properly used.** Use of these devices can reduce dust related hazards.

#### 4) Power tool Use and Care

- a) **Do not force the power tool. Use the correct power tool for your application.** The correct power tool will do the job better and safer at the rate for which it was designed.
- b) **Do not use power tool if switch does not turn it on or off.** Any power tool that cannot be controlled with the switch is dangerous and must be repaired.
- c) **Disconnect the plug from the power source before making any adjustments, changing accessories, or storing the power tools.** Such preventive safety measures reduce the risk of starting the power tool accidentally.
- d) **Store idle power tools out of reach of children and do not allow persons unfamiliar with the power tool or these instructions to operate the power tool.** Power tools are dangerous in the hands of untrained users.  
Do not let visitors touch the tool or extension cord. All visitors should be kept away from work area.
- e) **Maintain power tools. Check for misalignment or binding of moving parts, breakage of parts and any other condition that may affect the power tools operation. If damaged, have the power tool repaired before use.** Many accidents are caused by poorly maintained power tools.  
Inspect extension cords periodically and replace, if damaged.
- f) **Keep cutting tools sharp and clean,** properly maintained cutting tools with sharp cutting edges are less likely to bind and are easier to control.
- g) **Use the power tools, accessories and tool bits etc., in accordance with these instructions and in the manner intended for the particular type of power tool, taking into account the working conditions and the work to be performed.** Use of the power tool for operations different from intended could result in a hazardous situation.

#### 5) SERVICE

- a) Have your power tool serviced by qualified repair person using only identical replacement parts, this will ensure that the safety of the power tool is maintained.

#### **Additional information shall be provide**

- a) Instruction for putting into use
  1. Setting-up or fixing power tool in a stable position as appropriate for power tools which can be mounted on a support.
  2. Assembly
  3. Connection to power supply, cabling, fusing, socket type and earthing requirements.
  4. Illustrated description of functions.
  5. Limitations on ambient conditions.
  6. List of contents.
- b) Operating Instructions.
  1. Setting and testing.
  2. Tool changing.
  3. Clamping of work.
  4. Limits on size of work piece.
  5. General instructions for use.
- c) Maintenance and servicing.
  1. Regular cleaning, maintenance, and lubrication.
  2. Servicing by manufacture or agent, list of addresses.
  3. List of user-replaceable parts.
  4. Special tools which may be required.

**WARNING !**   
**DO NOT OPERATE THIS TOOL WITHOUT  
PROTECTIVE EARTH CONNECTED**

**Grounding Instructions**

1. This tool should be grounded while in use to protect the operator from electric shock. NOTICE! To ensure the grounding result, the grounding conductor of the power cord must be well connected with the grounding terminal of power facility. This tool is equipped with grounding conductors. The Green (or Green and Yellow) conductor in the Power Cord is the grounding wire. Never connect Green (or Green and Yellow) to a live terminal. The grounding wires in this tool can not only earth the electric leakage safely, but also can eliminate ESD-the electrostatic that tool occurred while in use.
2. The grounding is the most important task a user. Periodically, depends on the working condition and circumstance, for maintaining a good function the user has to check the grounding condition every 3~6 months by an electric meter and following simple steps; Set the Ohm meter to level R\*100(Ohm). Touching 2 test rods (“+” & “-”) together and reset the meter to “0”. Using the Red(“+”) rod to touch the Grounding wire on the Plug of controller’s cord, and the Black(“-”) rod to the end of Bit Head. It stands for the grounding is normal if the meter is read as close as to “0”. For getting a normal indication on the meter while in testing, need to press the test rods firmly to the testing objects.
3. The instrument QC of the tool is performed before the tool ex-factory. The grounding continuity test is conducted by input 26A voltage to the end of earth terminal, and subject to the resistance value lower than 0.3Ohm.

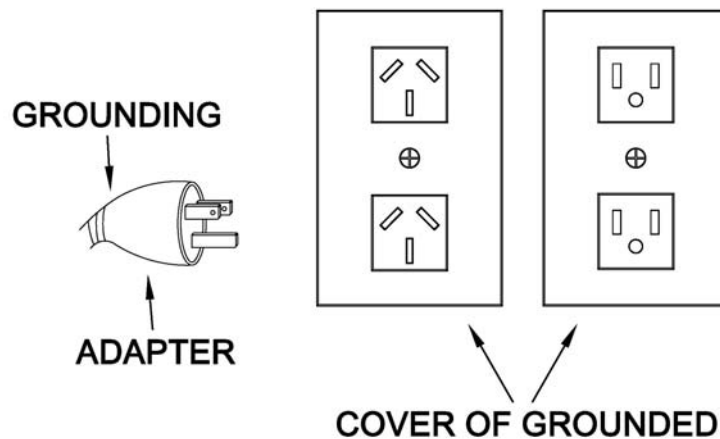

## Operations Cautions

- 1) Whenever changing a bit, make certain the Forward / Reverse Switch is in the “OFF” position and tool is unplugged.
- 2) Do not allow chemicals such as acetone, benzene, thinner, trichloroethylene ketone, or other similar chemicals to come in contact with the screwdriver housing as damage will result.
- 3) Do not drop or abuse the screwdriver.
- 4) Do not adjust the torque setting higher than 8 on the torque scale.
- 5) There should be a tool rest interval when cycles three seconds or longer. This tool is intended for a duty cycle of 1.0 sec on, 3.0 sec off.
- 6) Do not use this screwdriver for tightening wood screws. This is “Metal Assembly Screw Driver”
- 7) Do not operate the Forward / Reverse Switch the motor is running.
- 8) Whenever a tool is not being used, move the Forward / Reverse Switch to the “OFF” position and unplug the screwdriver.
- 9) Don't touch For&Rew Switch during operating for keeping system from wrong judgment.

### CAUTION

- Do not drop or abuse the tool.
- Whenever a tool is not being used, position the Power Switch to the “OFF” position and unplug the power cord.

## Description of Operation

Attaching / detaching bit and bit type

Push up the holder clamp by finger tip, and it will be unlocked. Thus, the bit can be freely attached and detached (single finger notion type) select such a bit whose shank is equal to the size shown below.

- Insert the power plug into a receptacle and set the changeover switch to “F” position.
- Apply the bit to the screw head and press the lever or push main body to, then the switch will be turned ON to start the motor running.
- When the screw is tighten and reach the torque that you had set, The tool will stopped automatically.
- To reset the tool by releasing the lever to the original position or releasing the bit from the screw head.
- To return the screw, set the changeover switch to “R” position.

## Servicing

### Maintenance and Inspection:

1. The screw driver must be operated in top condition, one day working hour must be not more than eight hours.
2. Please note don't let the motor get over heated, every minute use 10~15 screws to operate.
3. The frequency use of this electric screw driver is over than eight hours a day, still it needs periodically testing and treatment. Every 5-6 months.
4. Inspect tool cords periodically and if damaged, have them repaired by an authorized service facility. Inspect extension cords periodically and replace if damaged.
5. Do not remove any labels. Replace any damaged label.

**CAUTION**

1. The use of other than genuine KILEWS replacement parts may Result in decreased tool performance and increased maintenance, and may invalidate all warranties.
2. All repairs and maintenance of this tool and its word must be performed by an authorized service center.
3. KILEWS is not responsible for customer modification of tools for applications on which KILEWS was not consulted.
4. Repairs should by made only by authorized, trained personnel. Consult your nearest KILEWS authorized service center.
5. It is the responsibility of the employer to place the information in this manual into the hands of the operator.

**DO NOT ATTEMPT TO REPAIR THIS  
ELECTRIC SCREW DRIVER**

**CAUTION**

**SAVE THESE INSTRUCTIONS  
DO NOT DESTROY**

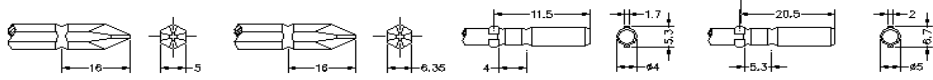

## Specifications

MODEL		SKD-BE512L	SKD-BE519L	SKD-BE512P	SKD-BE519P
Input voltage(DC)		DC 24V OR 32V			
Power Consumption		55W			
Torque	(kgf.cm)	1.5-12	3-19	2-12	3-19
	(Lbf.in)	1.33-10.44	2.57-16.46	1.77-10.44	2.57-16.46
	(N.m)	0.15-1.18	0.29-1.86	0.2-1.18	0.29-1.86
Repeatable Torque Accuracy (%)		±3%			
Torque Adjustment		Step less			
Unloaded Rotation Speed (r.p.m) ±10%	HI	1000	1000	1000	1000
	LO	700	700	700	700
Screw Size Dia(mm)	Machine screw	1.6~3.0	2.3~3.5	1.6~3.0	2.3~3.5
	Tapping screw	1.6~2.6	2.3~3.0	1.6~2.6	2.3~3.0
Weight (g)		580			
Length (mm)		270			
Model of Torque Fixing Ring		KC-6C · KC-6S			
Power controller		SKP-32B-60W			
Model of Suspension Rack		KH-4 · (KC & KH-2)			
Bit Type					
		HEX 5mm,	HEX 6.35mm	Ø4mm,	Ø5mm

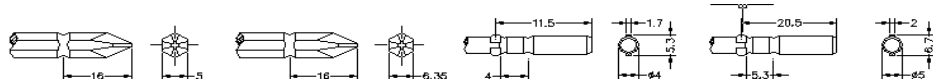
MODEL		SKD-BE512LF	SKD-BE512PF	SKD-BE517LF	SKD-BE517PF
Input voltage(DC)		DC 32V			
Power Consumption		55W			
Torque	(kgf.cm)	1.5-12	2-12	3-17	3-17
	(Lbf.in)	1.33-10.44	1.77-10.44	2.57-14.78	2.57-14.78
	(N.m)	0.15-1.18	0.2-1.18	0.29-1.67	0.29-1.67
Repeatable Torque Accuracy (%)		±3%			
Torque Adjustment		Step less			
Unloaded Rotation Speed (R.p.m) ±10%	HI	2000	2000	2000	2000
	LO	-	-	-	-
Screw Siz Dia(mm)	Machine screw	1.6~3.0	1.6~3.0	2.3~3.5	2.3~3.5
	Tapping screw	1.6~2.6	1.6~2.6	2.3~3.0	2.3~3.0
Weight (g)		580			
Length (mm)		270			
Model of Torque Fixing Ring		KC-6C · KC-6S			
Power controller		SKP-BE32HL			
Model of Suspension Rack		KH-4 · (KC & KH-2)			
Bit Type					
		HEX 5mm,	HEX 6.35mm	Ø4mm,	Ø5mm

\* 1N.m=10.2Kgf.cm    1N.m=8.85Lbf.in

## Accessories

1. Bit Type : No. 00 . . . Bit use in dia 1.3~1.8mm screw  
 No. 0 . . . . Bit use in dia 1.8~2.0mm screw  
 No. 1 . . . . Bit use in dia 2.0~2.6mm screw  
 No. 2 . . . . Bit use in dia 3.0~4.0mm screw  
 SKD-BE512 with BIT 1# & 2# 1 Pcs. Each  
 SKD-BE519 with BIT 1# & 2# 1 Pcs. Each  
 SKD-BE512F with BIT 1# & 2# 1 Pcs. Each  
 SKD-BE517F with BIT 1# & 2# 1 Pcs. Each
2. Suspension rack and Torque fixing ring acceptable for use with the tool are available from KILEWS catalogue.
3. Torque Fixing Ring (KC-6C) 1 Pcs.

## Panel Specifications

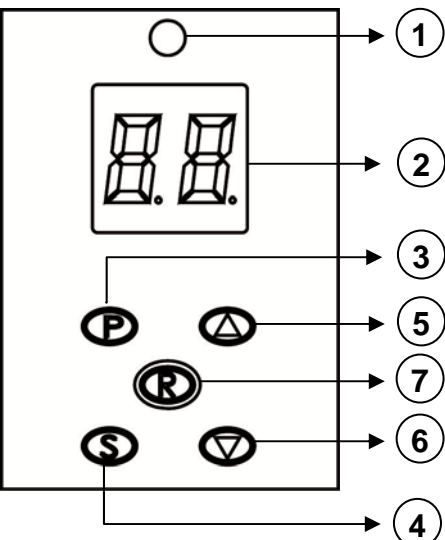
	NO	Name	Function
	1	Three-Color Light	To Show operating is OK, N.G or in the mode condition.
	2	Panel	To show set value, set screws number and other value
	3	Power Switch	Push five seconds: to disable COUNTING FUNCTION CLEAR Push three seconds: CLEAR
	4	SELECT Key	Push three seconds: Enter the system
	5	Up Key	When entering the system , this key increases value
	6	Down Key	When entering the system , this key decreases value
	7	Reset	Restore to factory settings
	※	S+P	Automatic learning.
	※	UP+P	Waiting time mode
	※	UP+DOWN	Buzzer mode
	※	S+UP	If press together to enable P/R/S button, and then press again to disable P/R/S button.

# Counting Set-Up instruction

※Push three seconds to enter the selection ) SL===SC===At===Ht===Lt===LL===Ns===Rn===Rt <Confirm>

Function Name	Set up Time and Value	Description	Buzz Time/ Light	Factory default settings
SL	01-05/UU	Screw List	---	---
SC	1-99	Counting number / count-down only	---	05
At	0.1-9.9	Automatic zero time / Signal output time	---	1.0
Ht	0.1-9.9	Ht time Stop time ( Show wrong as screwdriver can't sop at set time after starting, can be used to test stripped screws	Five buzz and LED red flash	2.0
Lt	0.01-9.9	Lt time will show wrong as screwdriver stops before Lt after starting, can test screw is not properly fastened at its position. .	Two buzz and LED red flash	0.00
LL	0.01-9.9	Reconfirm time after fastening.	---	0.00
Ns	Y or N	Ns : Set the function of stopping the screwdriver when any error message occurs. Y: Stop the screwdriver when any error occurred meanwhile, Reverse is OK; Restore by pressing "S" button N: screwdriver could operate continually when any error occurred.		
Rn	Y or N	Rn : Set the count-up mode for the reversion. Y:taken in count for each reversion : N:Only count once when reverse		
Rt	0.01 – 9.99	Rt : Set auto reverse time after the screwdriver shutting off.		
Backward to Count-Up	1 COUNT	When screwdriver is backward, the number will be back one	---	---
LC	---	Keypad LOCK P/S/R button		
UN	---	UNLOCK		
Ln	---	Automatic learning.	LED keeps flash of light	---
Buzzer	En Wrong Set-Up	Wrong Set-Up, such as Lt > Ht	Three buzz and LED red flash. Automatically show En	---
	dt Standby Time	Seconds	buzz if set-number of screws are not completed in the allotted set time for each screw fastening	---
	Tt Working Time for a set of screwdriver	Minutes	buzz if set-number of screws are not completed in the allotted set time for a set screw fastening °	

※In the set-up , if Lt and LL show "02."means 0.02, push P to adjust decimal to become 0.2.

※During operation, LED will show three kinds of colors: OK is green light; NG is red light; standby learning is orange light.

※SKD-BE PCB has three kinds of signal, OUTPUT OK1, OKALL and N.G and is an open collector type.

※Output users need input voltage to drive the buzzer, the input voltage can't be over DC24V 10mA.

※There is a new judgment which is the screwdriver will judge a N.G.in the case of there is a start signal and it is OFF before Lt.

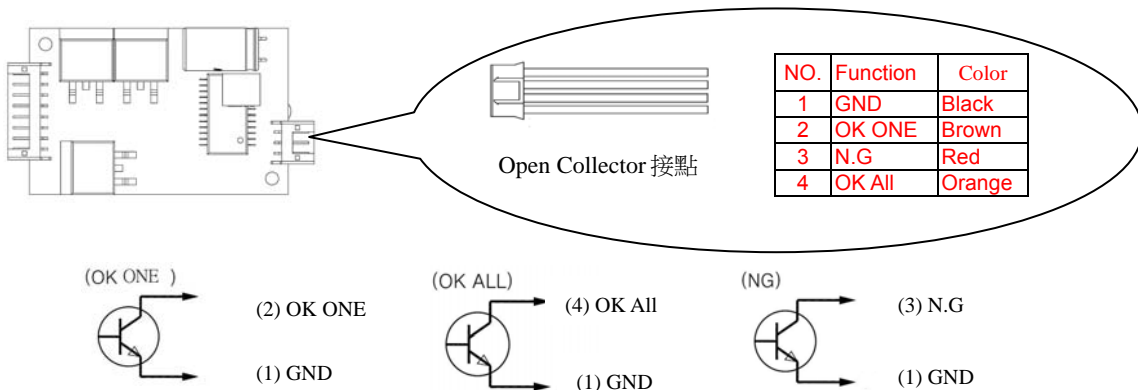

Push both UP + DOWN set up the buzzer :

ON	Fastening a screw, completing work and mistaken operation, buzzer will be on.
OFF	Wrong operation will be buzzed.
FF	Work completed and wrong operation will cause buzz.
EF	As one screw is fastened and work is completed, buzzer will be on; as mistake made has no buzz.

## Ht/Lt Description:

Ht/Lt mainly set up the period of time. If stop is within the set period, it means OK. In contrast, it will be (NG), as stop before Lt or after Ht. and should reconfirm whether wrong screws is taken. More accuracy requested means more correct Ht/Lt set-up should be. The LT accepts 0.00, but it can be increased or decreased in SELECT.

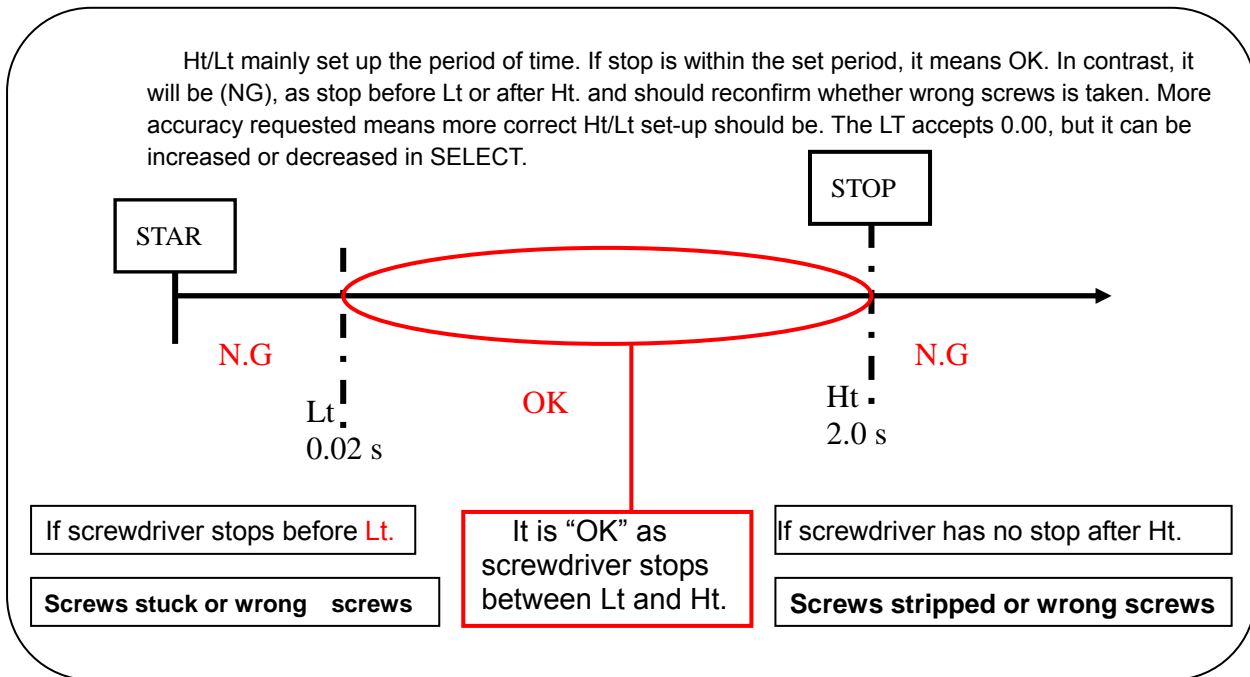

※To shut down the count: If count needs be shut down, push P key for five seconds until no figures on the panel, meanwhile LED 1 will show green light.

※If set value need be reset during counting, just push three seconds.

※Simulate-learning: as electric screwdriver is not used, push S key and then push P key to enter simulate-learning procedure;

SL(S)===SC(S)===At(S)=== Test Data===(P)

- 1) Show SL (Screw List), select UP/DOWN to change number and then push S(confirm)
- 2) Show SC (counting number), select UP/DOWN to change number and then push S(confirm)
- 3) Show At (automatic zero), UP/DOWN to change value; then push P (confirm)
- 4) Enter simulate-learning (LED 1 will keep flash)
- 5) When recording value, push P key and back working condition.

※LED light flash in simulate-learning.( means under simulate- learning condition), push P key to record value after simulate -learning. )

※As no use of screwdrivers: UP and push P key can set up waiting time.

If three seconds are set, but no starting signal after set time, it will buzz.

※Push R key to restore to factory settings.

General execution of pre-set program:

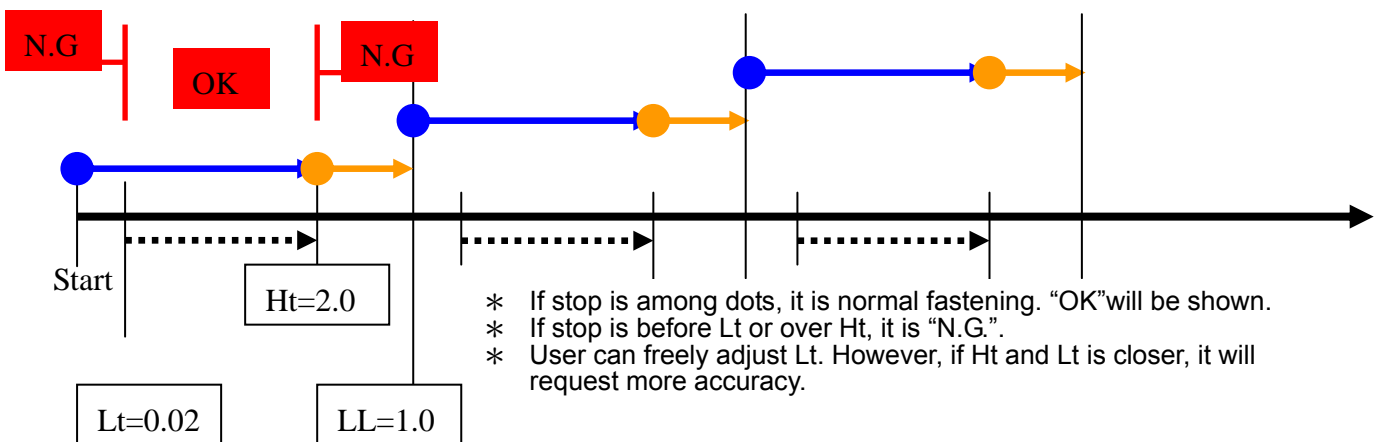

## Torque Adjustment Operation

To adjust the torque on these screwdrivers. Proceed as follows :

1. Determine the torque output of the tool by checking a tightened Fastener with a torque wrench.
2. Increase or decrease the torque by rotating the Spring Adjusting Ring. Rotating the Ring clockwise to a higher number on the torque Scale increase torque output while rotating the Ring counterclockwise to a lower number decreases the torque output.
3. Check the adjustment with a torque wrench. A number of factors will affect torque output from one job to another. Final torque adjustment should be made at the job through a series of gradual increase. Always start below the desired torque and work upward.
4. Adjust the bit torque by changing the driving in length of the adjust ring at the end.
5. The relationship between torque scale and bit torque is as shown Ring, in the torque diagram. The figures of torque scale do not indicate bit torque values. However, the clamping torque of screw itself is different from type, size, material of the screw and the material of its mating part. Use it as standard to obtain an appropriate clamping torque.
6. The (Return torque method) in which once-clamped screw is returned with torque wrench or the like is available as one of torque control methods however, note that the measured values by the return torque method generally appear in 10%~30% lower than the actually clamping torque.
7. The torque checker measures the torque of screwdriver. The clamping torque of screw itself is different from the clamped conditions. Understand the correlation between clamping torque values and the torque checker values perform the torque control properly.

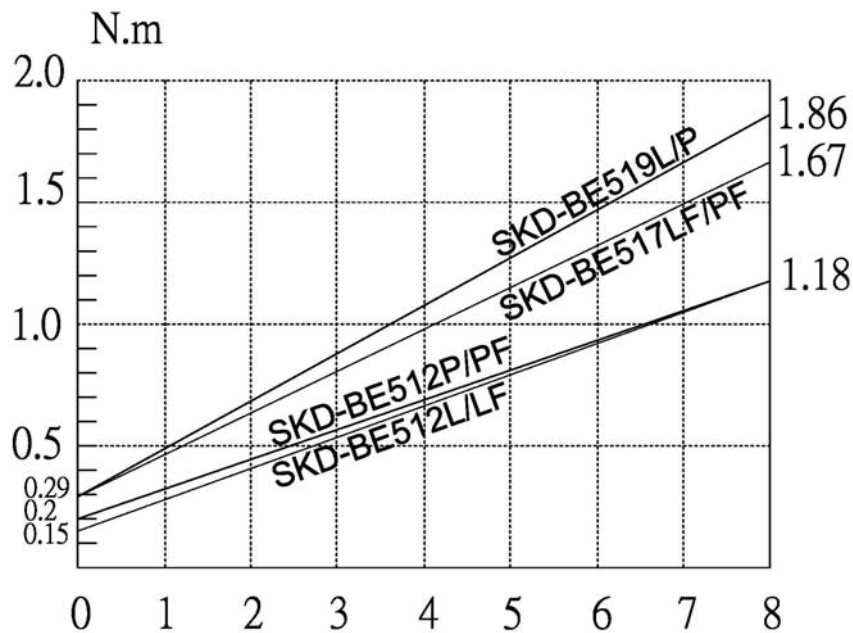

**CAUTION**

1. Also in reverse rotation, the clutch is turned off in such manner as in normal rotation, stopping the motor running. Accordingly, when the screw tightened at a large torque, set it to a higher torque scale.
2. The number from zero to eight on the Torque Scale is reference number only and not an indication of actual torque output.
3. The power supplier will generate low power when the button of the power controller is switched to "LO." Also, the electric screwdriver's torque output setting value should be adjusted to middle torsion value accordingly.
4. The mechanical wear condition of the electric screwdriver depends on the torque, duration, and the frequency that user used. In the case of using greater torque, the higher frequency and the longer operation, the screwdriver will get worn faster. The new screwdriver uses in the scale of 4 for one month (frequency: 12 pcs/ min; 8 hours / per day) will result in 3% ~ 5% torque decay. (Scale of 8 will result in 5% ~ 7% torque decay). By the growth in use of time, the torque decay level will gradually reduce and stabilize. User could test the torque output of the screwdriver by torque meter periodically and then adjust it to meet user's requirement for the compensation of the torque decay.
5. Please refer to Kilews website <http://www.kilews.com> for the detail component list.

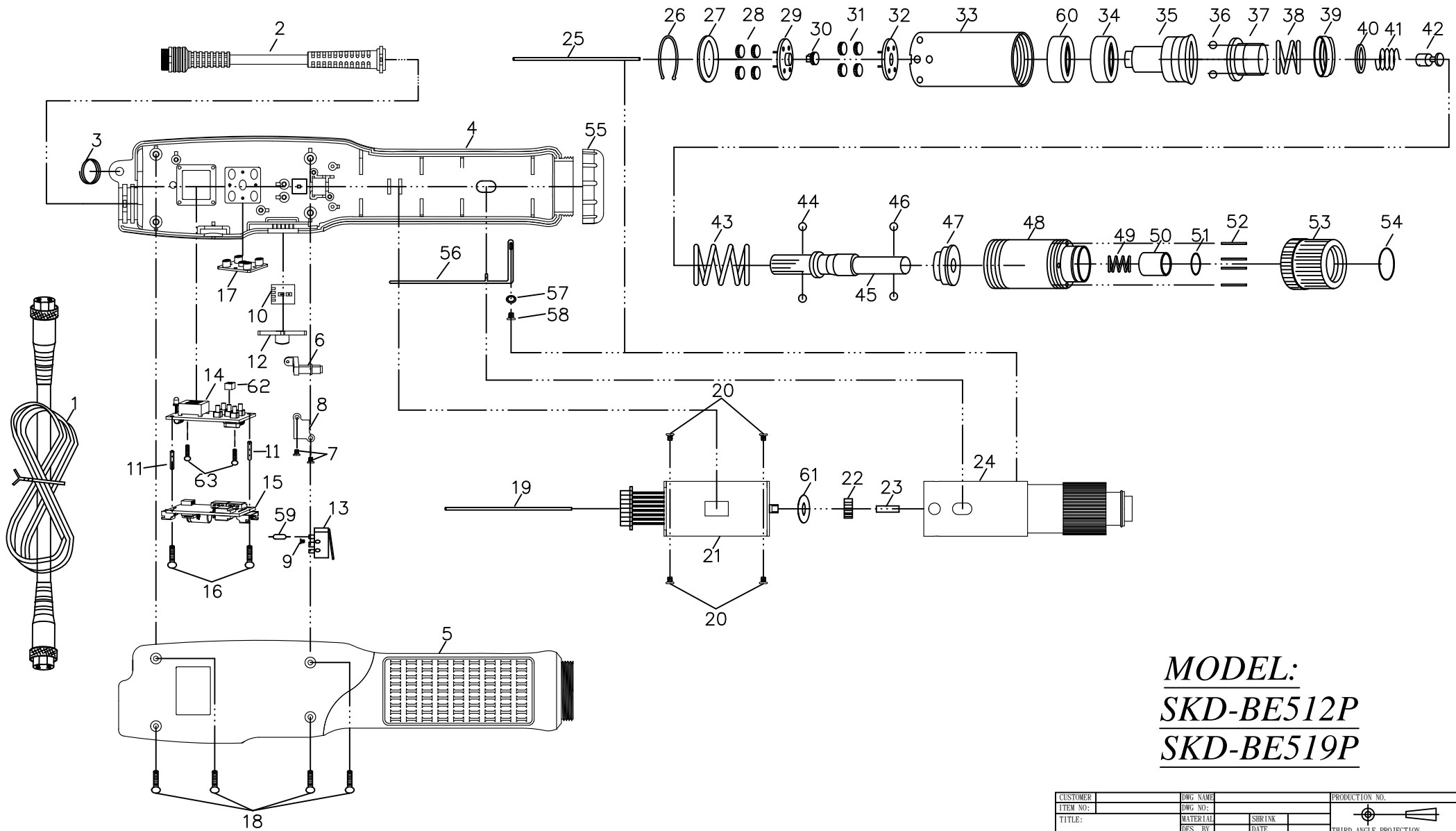

**MODEL:**  
**SKD-BE512P**  
**SKD-BE519P**

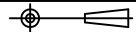
CUSTOMER	DWG NAME	PRODUCTION NO.	
ITEM NO:	DWG NO:		
TITLE:	MATERIAL	SHRINK	THIRD ANGLE PROJECTION.
	DES. BY	DATE	UNIT
	CHKD. BY	DATE	SCALE
	APPD. BY	DATE	SHT NO.
			OF SHTS.

NO	PARTS NO	PARTS NAME-E	PARTS NAME-C	Qty	NO	PARTS NO	PARTS NAME-E	PARTS NAME-E	Qty
1	AA50001-26	CORD ASSEMBLY 2M	電源線2M	1	34	GN30321	MAIN BEARING	離合器主軸承	1
2	AA50001-52N	CORD ASSEMBLY	檔尾電源線	1	35	GX33319-4	SHAFT GUIDE	上離合器頭	1
3	CJ20011	SUSPENSION RING	起子吊環	1	36	GP30351	STEEL BALLS	跳脫鋼珠	2
4	C40745F	HOUSING-UNDERSIDE (A'ssy) (BLUE-BLACK)	下蓋半成品(白-黑)	1	37	GF33317	WARING PLATE	扭力推盤	1
	C40745-1F	HOUSING-UNDERSIDE-ESD (A'ssy)	下蓋半成品-防靜電	1	38	GO30541	SPRING FOR "BE512P"	兩段式小彈簧(BE512P)	1
5	CA50233	HOUSING-UPSIDE (WHITE-BLACK)	外殼上蓋(白-黑)	1		GO30544	SPRING FOR "BE519P"	兩段式小彈簧(BE519P)	1
	CA50233-1	HOUSING-UPSIDE ESD	外殼上蓋(ESD)	1	39	GO30531	SPRING CAP	彈簧蓋	1
6	CE50152-3	PUSH ROD	開關推桿半成品	1	40	GV33316	INNER SPRING CAP	下壓式彈簧蓋	1
7	CH30200	SCREW FOR FIXTURE	螺絲	2	41	GO33315-2	INNER SPRING FOR "BE512P"	下壓式內彈簧 (BE512P)	1
8	CE80001	FIXTURE	三合一固定片	1		GO33315	INNER SPRING FOR "BE519P"	下壓式內彈簧 (BE519P)	1
9	CH20511	SCREW FOR SHUT OFF SWITCH	螺絲	1	42	GU30361	STOP PILOT FOR "BE512P"	停止用酒杯 (BE512P)	1
10	EG31421-1	PCB	機板成品	1		GU30370	STOP PILOT FOR "BE519P"	停止用酒杯 (BE519P)	1
11	W50110	PC BOARD GAP COLUMN	PC板間隔柱	2	43	GE30411-18	WRING SPRING FOR "BE512P"	扭力彈簧 (BE512P)	1
12	CI50212-1	F/R SWITCHING ELEMENT "BE512P"	正反轉推板半成品 (BE512P)	1		GE30413-8	WRING SPRING FOR "BE519P"	扭力彈簧 (BE519P)	1
	CI50212	F/R SWITCHING ELEMENT "BE519P"	正反轉推板半成品 (BE519P)	1	44	GP30371	STELL BALLS	酒杯鋼珠	2
13	H10203	SHUT OFF SWITCH	剎車開關	1	45	GD33319A	SHAFT FOR "A" TYPE	傳動軸(A頭)	1
14	EG31418-15F	PCB	計數機板成品	1		GD33319B-2	SHAFT FOR "B" TYPE	傳動軸(B頭)	1
15	EG31418-16	PCB	驅動機板成品	1		GD33319C	SHAFT FOR "C" TYPE	傳動軸(C頭)	1
16	CH90122-2	SCREW	螺絲	2		GD33319D	SHAFT FOR "D" TYPE	傳動軸(D頭)	1
17	C50213-1	BOTTOM	矽膠按鍵	1		GD33319AD	SHAFT FOR "AD" TYPE	傳動軸(AD頭)	1
18	CH20102	SCREW	螺絲	4	46	GP20331	BIT PILOT FOR "A&D"	起子頭帽鋼珠(A&D用)	2
19	MI90302	PILOT ROD	開關引導棒	1		GP21291B	BIT PILOT FOR "B&C"	起子頭帽鋼珠(B&C用)	2
20	CH20102-24	SCREW FOR MOTOR	馬達螺絲	4	47	GY33313	WRING SPRING BASE	止推盤	1
21	MO50113-ICE	MOTOR ASSEMBLY	馬達整組	1	48	GB20381-8	CLUTCH CASE FOR "A.C.D"TYPE	下離合器筒(A.C.D用)	1
22	M11322-1	GEAR	馬達主齒	1		GB20381-9	CLUTCH CASE FOR "B"TYPE	下離合器筒(B用)	1
23	MG91081	PILOT ROD	陶瓷棒	1	49	GO30452	BIT SPRING FOR "BE512P< BE519PA,C,D"	起子頭帽彈簧 (BE512P BE519PA,C,D)	1
24	GZ51902-1A-J	CLUTCH ASSEMBLY FOR "BE512PA"	離合器整組 (BE512PA)	1		GO20391B-J	BIT SPRING FOR "BE512PB"	起子頭帽彈簧 (BE512PB)	1
	GZ51902-5B-J	CLUTCH ASSEMBLY FOR "BE512PB"	離合器整組 (BE512PB)	1		GO20391B	BIT SPRING FOR "BE519PB"	起子頭帽彈簧 (BE519PB)	1
	GZ51902-1C-J	CLUTCH ASSEMBLY FOR "BE512PC"	離合器整組 (BE512PC)	1	50	GJ30461	BIT SLEEVE FOR "A,C,D"	起子頭帽(A,C,D)	1
	GZ51902-1D-J	CLUTCH ASSEMBLY FOR "BE512PD"	離合器整組 (BE512PD)	1		GJ3046B	BIT SLEEVE FOR "B"	起子頭帽(B)	1
	GZ51902-1AD-J	CLUTCH ASSEMBLY FOR "BE512PAD"	離合器整組 (BE512PAD)	1	51	GQ30471	"C" RING FOR GJ30461"A,C,D"	起子頭帽C環(A,C,D)	1
	GZ51902-2A	CLUTCH ASSEMBLY FOR "BE519PA"	離合器整組 (BE519PA)	1		GQ21361	"C" RING FOR GJ30461"B"	起子頭帽C環(B)	1
	GZ51902-5B	CLUTCH ASSEMBLY FOR "BE519PB"	離合器整組 (BE519PB)	1	52	GL30481-1	TORQUE ADJUST PING	扭力調整棒	4
	GZ51902-2C	CLUTCH ASSEMBLY FOR "BE519PC"	離合器整組 (BE519PC)	1	53	GM30491	TORQUE ADJUST RING	扭力調整環	1
	GZ51902-2D	CLUTCH ASSEMBLY FOR "BE519PD"	離合器整組 (BE519PD)	1	54	GS30501	"C"RING	扭力環C環	1
	GZ51902-2AD	CLUTCH ASSEMBLY FOR "BE519PAD"	離合器整組 (BE519PAD)	1	55	CD20111-1	COUPLER	前鎖環	1
25	MI30241	PILOT ROD	開關引導棒	1		CD20111-2	COUPLER ESD	前鎖環 ESD	1
26	GK20231	"C" RING	齒輪固定C環	1	56	CH50671-7	GROUNDING MEANS	接地線	1
27	GI20251-1	IRON WASHER	齒輪固定片	1	57	CH20102-8	WASHER	華司	1
28	GH20241	IDLE GEAR	游星齒輪	4	58	CH20514	SCREW	螺絲	1
29	GG20271	GEAR SEAT	齒盤	1	59	E30703	DIODE	二極體 1N4148	1
30	G20101	CENTRAL GEAR	中心齒	1	60	GN30435	MAIN BEARING	離合器主軸承	1
31	GH20241	IDLE GEAR	游星齒輪	4	61	W10201-1	INSULATING WASHER	絕緣墊片 (0.2mm)	1
32	GG20271	GEAR SEAT	齒盤	1	62	C50226	Fixture	開關保護蓋	1
33	GA91284	GEAR CASE	上離合器筒	1	63	CH90122	SCREW	螺絲	2